

BDS

Integrated home theater system

Quick-Start Guide







harman/kardon[®]
by HARMAN

Thank you for choosing a Harman Kardon® product!

This quick-start guide contains all the information you need to connect and set up your new BDS integrated home theater system.

To conserve our natural resources, your BDS system does not include a printed user manual. A user manual containing complete information about operating all of your new system's features is available at our Web site. Go to www.harmankardon.com and download the *BDS Integrated Home Theater System User Manual*.

USA:	EU:
 Blu-ray Disc™ region	 Blu-ray Disc™ region
 DVD region	 DVD region

Place the Speakers

5.1-Channel Systems

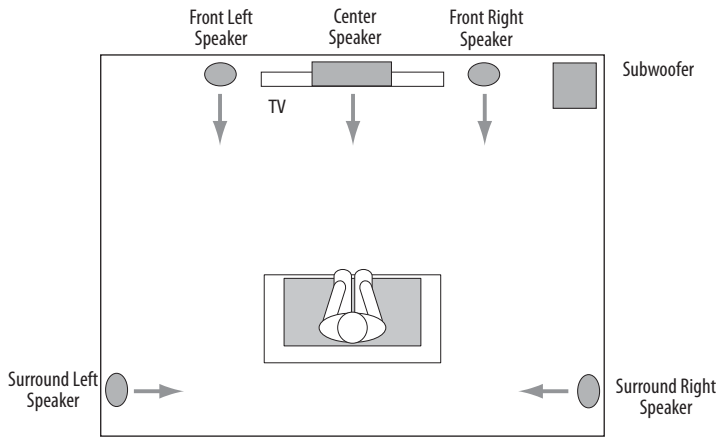

Soundbar Systems

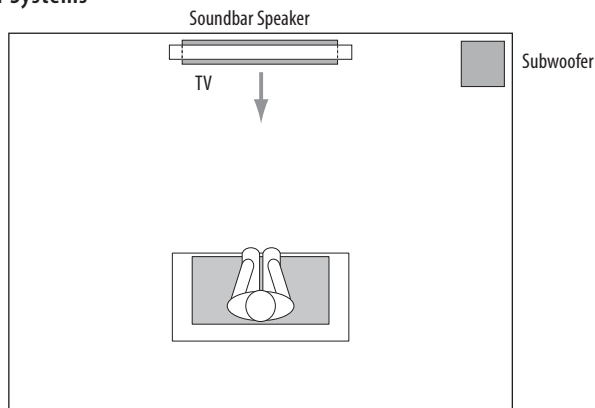

2.1-Channel Systems

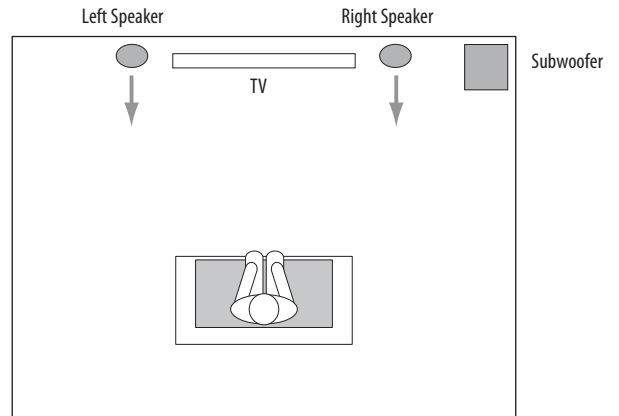

For more detailed speaker placement information – including wall-mounting instructions – download the complete *BDS Integrated Home Theater System User Manual* from www.harmankardon.com.

Connect the Speakers

CAUTION: Before making any connections to the BDS receiver, ensure that the receiver's AC cord is unplugged from the receiver and the AC outlet. Making speaker connections with the receiver plugged in and turned on could damage the speakers.

5.1 and 2.1 System Speakers Option 1

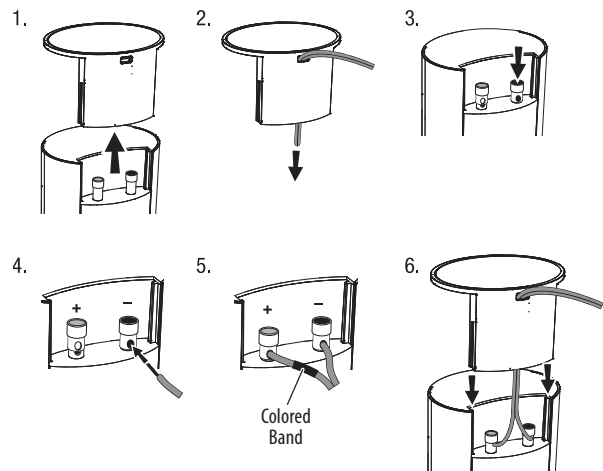

5.1 and 2.1 System Speakers Option 2

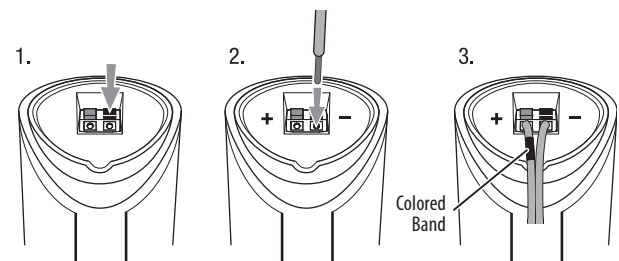

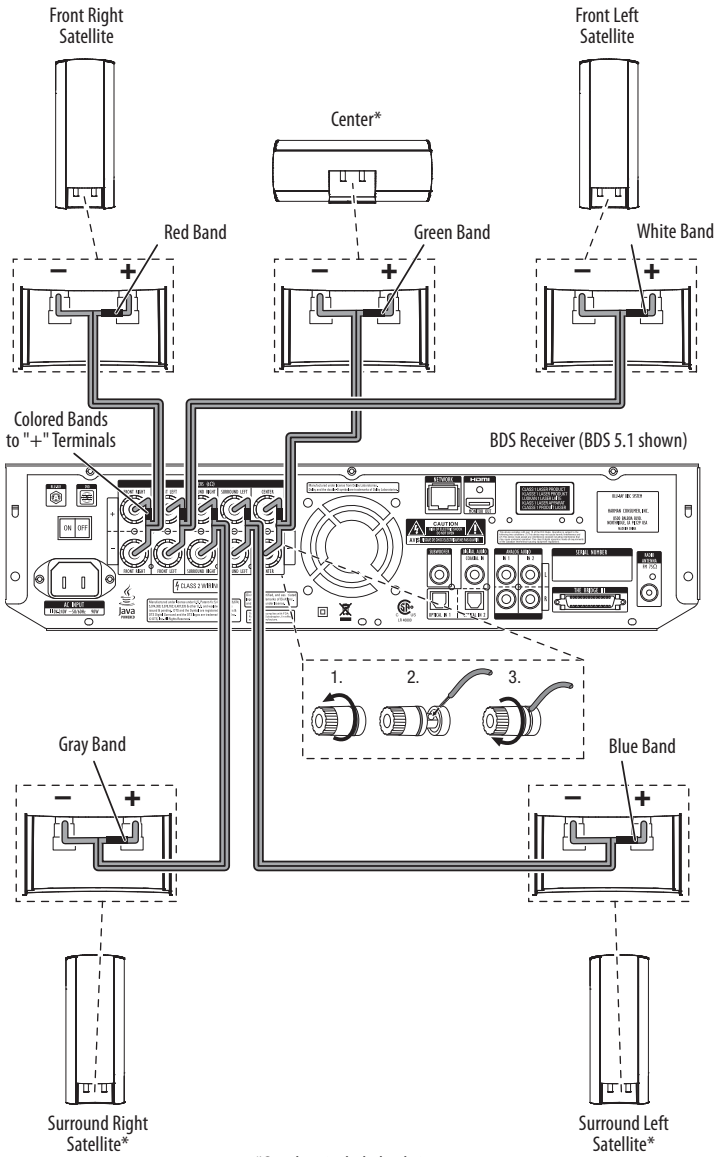

*Speakers included only in 5.1 system

IMPORTANT: Make sure the (+) and (-) bare wires do not touch each other or the other terminal. Touching wires can cause a short circuit that can damage the receiver.

3.1 Soundbar System

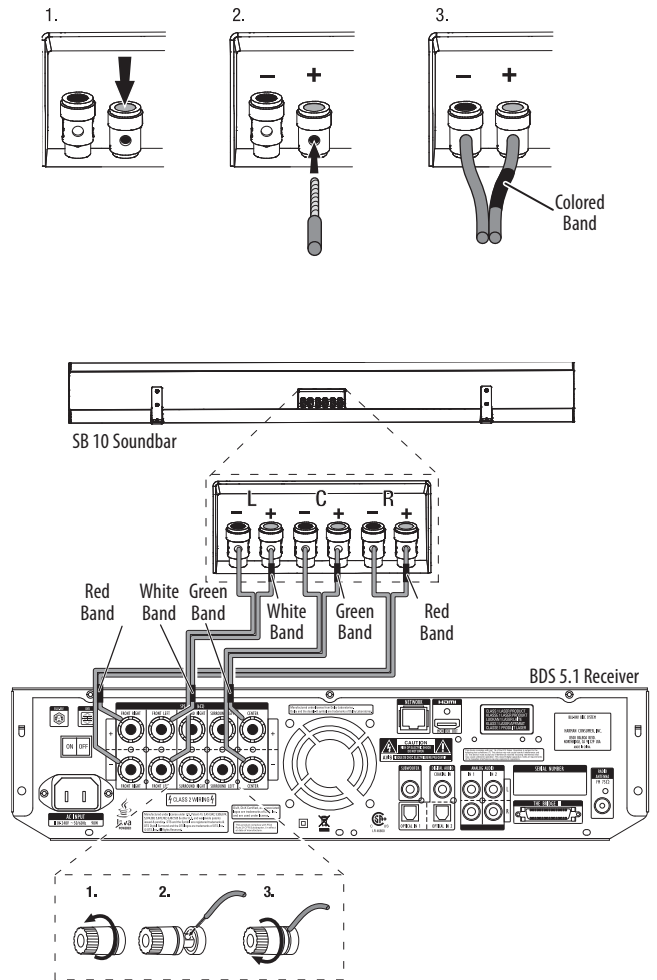

IMPORTANT: Make sure the (+) and (-) bare wires do not touch each other or the other terminal. Touching wires can cause a short circuit that can damage your receiver or amplifier.

Connect the Speakers (Continued)

Subwoofer Connection

IMPORTANT: Do not plug the subwoofer's AC power cord into an AC outlet at this time.

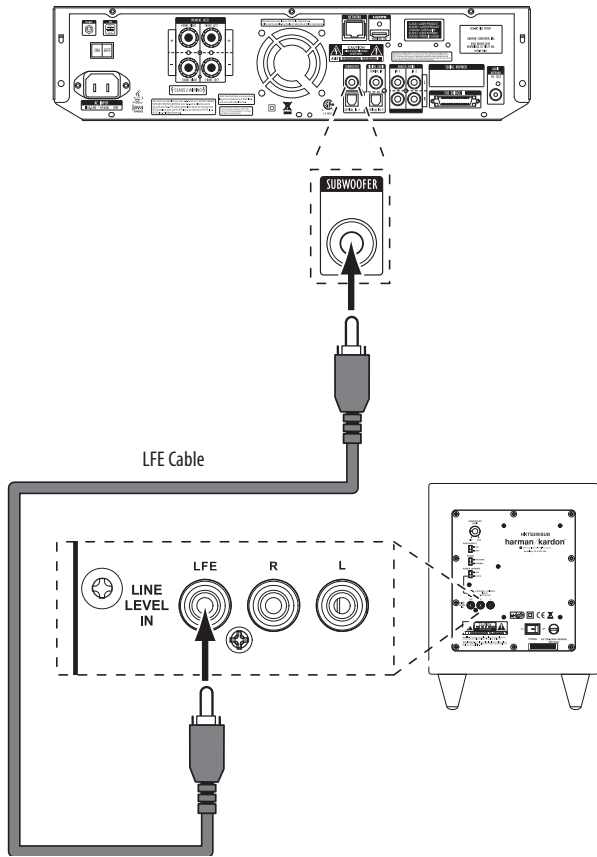

Connect a TV or Video Display

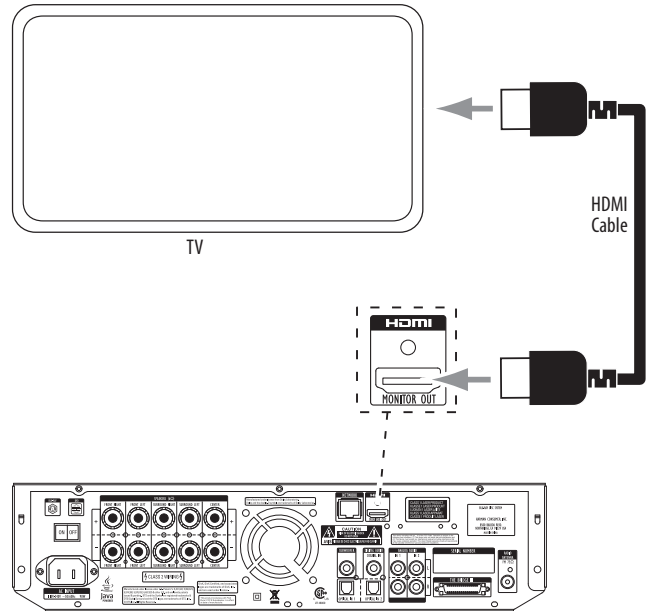

Connect to a Local Area Network (LAN)*

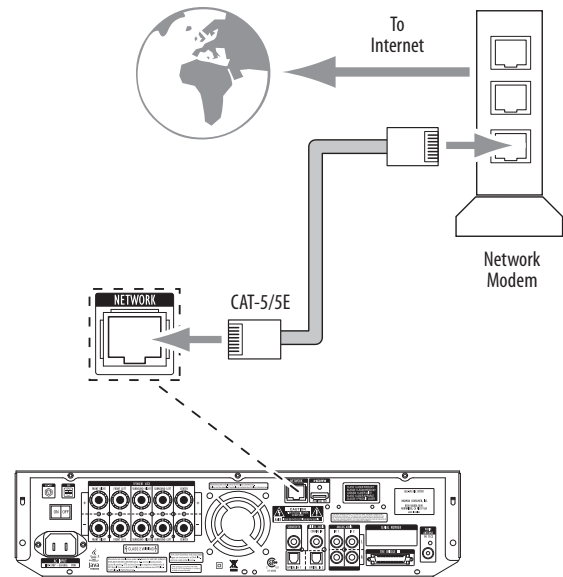

Connect Other Devices

Connect the Radio Antenna

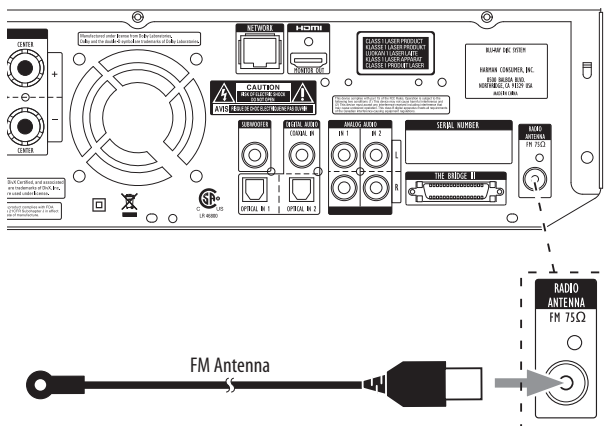

* Needed only for BD-Live™ functionality

Connect Audio Sources

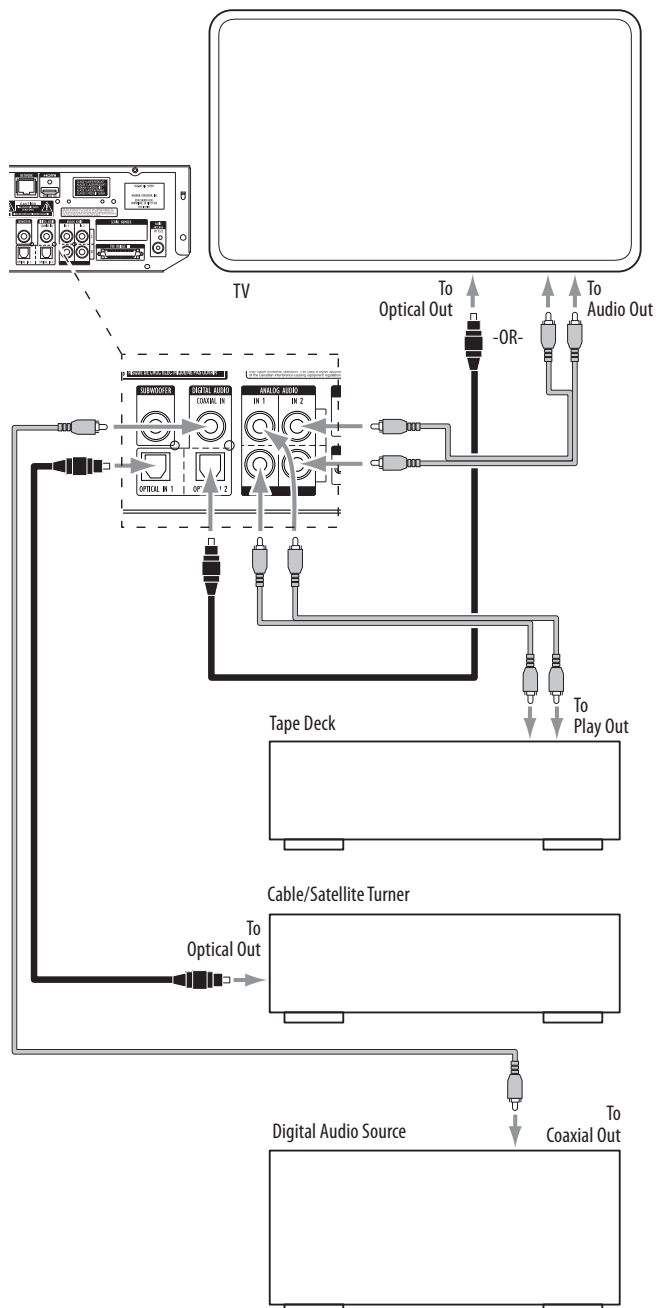

Connect the AC Power

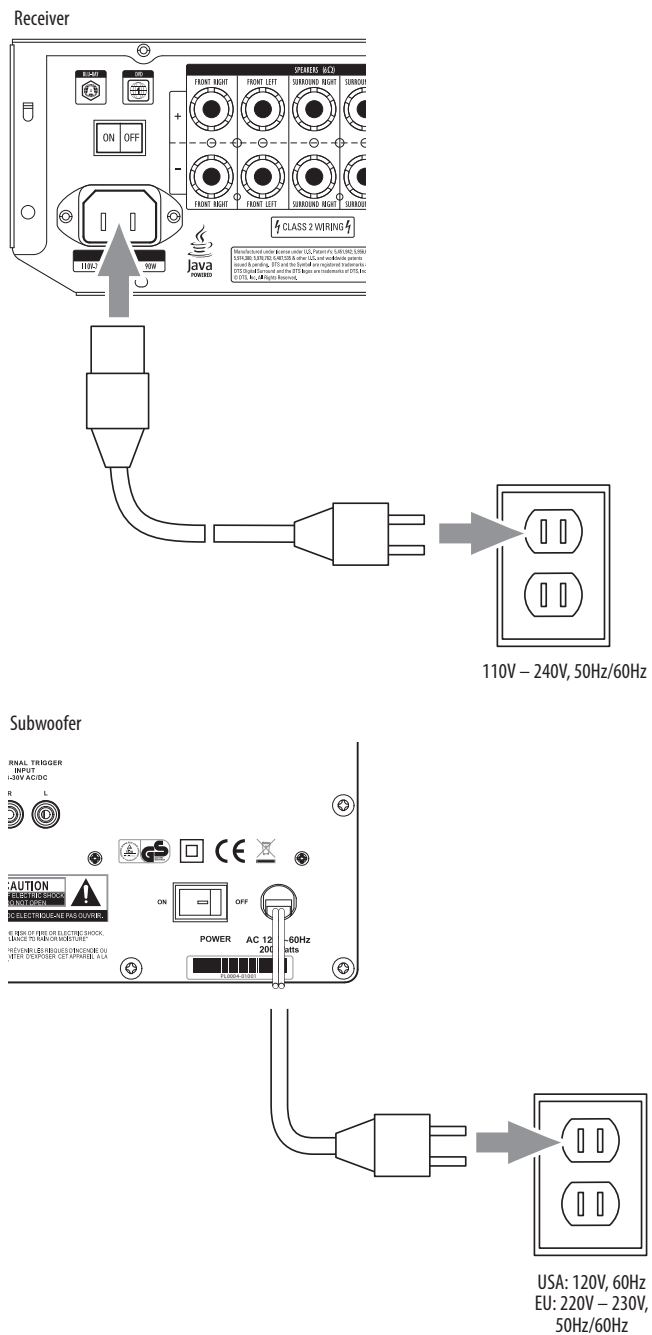

Set Up the Receiver

Install the Batteries in the Remote Control

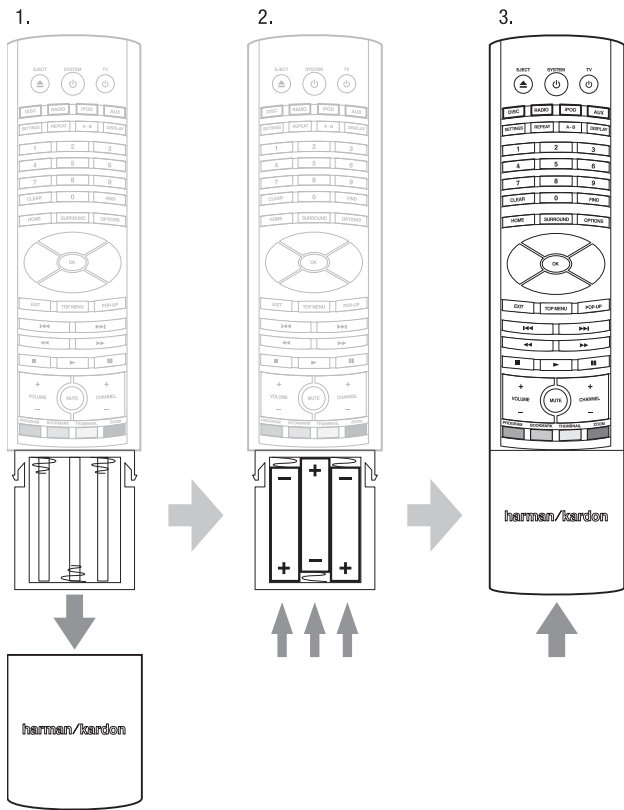

Set Up the Receiver

Set the receiver's and subwoofer's Main Power switches in the "On" position.

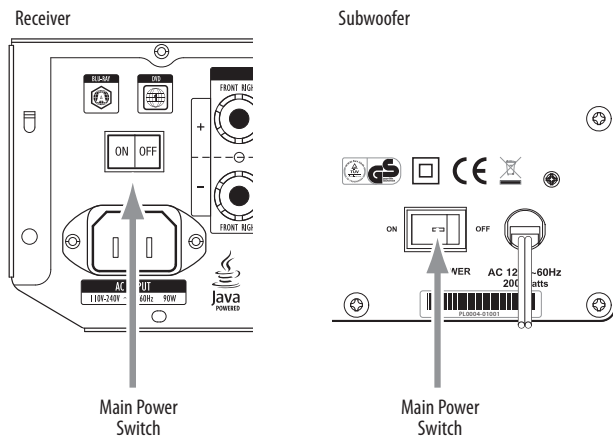

To set up your BDS receiver you will use the remote to navigate through the on-screen menus and to make selections from them.

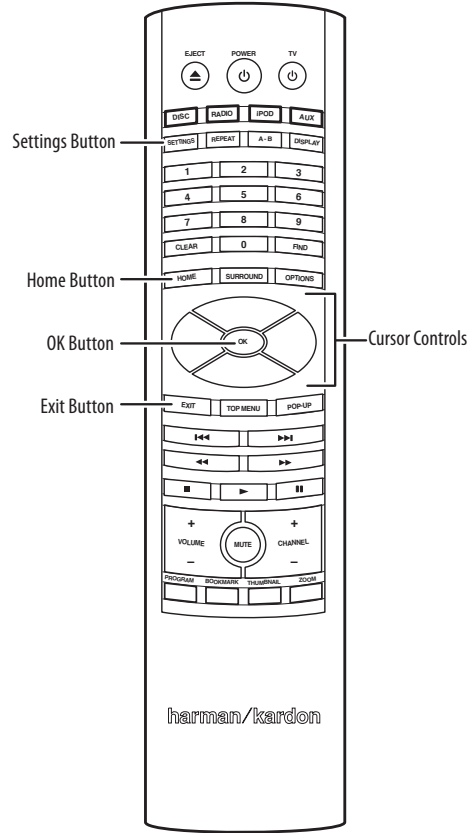

- Use the Cursor Up/Down buttons to navigate through the menu list. When an item is highlighted, a blue border will appear around it.
- To select a highlighted item, press the OK button. The screen will change depending on your selection.
- To return to the previous screen, press the Exit button.

Setup Wizard

When you turn your BDS receiver on for the first time, the on-screen menu will display the Setup Wizard.

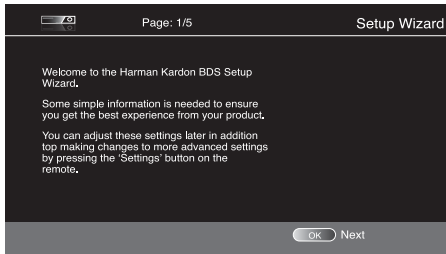

Before you can use your BDS system you need to set the language and make a few basic settings so that the BDS receiver's video output will work properly with your TV.

Press the OK button and the Wizard's language screen will appear.

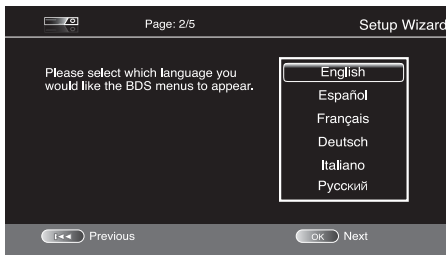

After setting the language you want the receiver's on-screen menus to appear in, press the OK button and the Wizard's TV resolution screen will appear.

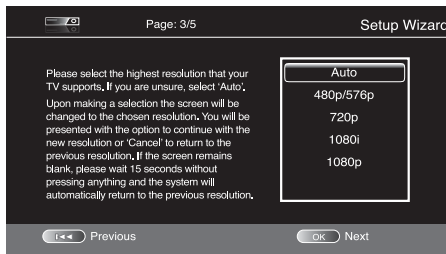

After selecting your TV's highest resolution, press the OK button, and the Wizard's aspect ratio screen will appear. NOTE: If you are unsure of your display's highest resolution, select "Auto" and BDS will select the optimal resolution for you.

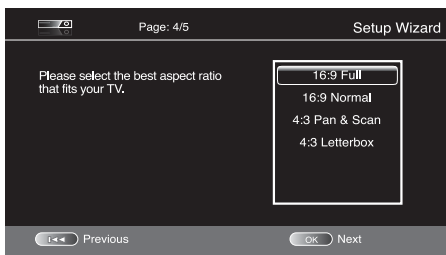

After selecting the aspect ratio that best fits your TV, press the OK button to save your setting, and then press it again to exit the Setup Wizard.

Soundbar System Setup

NOTE: These instructions apply only to BDS soundbar systems.

Before you can use your soundbar system, you must configure the receiver for 3.1-channel operation.

1. Press the remote's Settings button. The General Settings screen will appear.

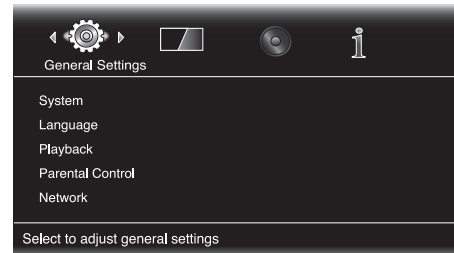

2. Press the right Cursor control to select Audio Settings. The Audio Settings screen will appear.

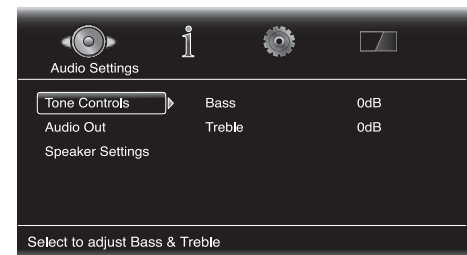

3. Press the down Cursor control to select Speaker Settings.

4. Press the right Cursor control to select Configuration, then press it again to highlight 2.1.

5. Press the down Cursor control to highlight 3.1.

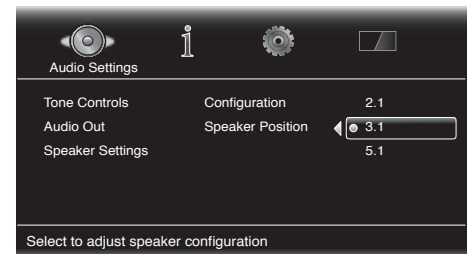

6. Press the OK button to select the configuration, then press the Settings button to exit.

Using the Receiver

Press the remote's Home button to display the Home Menu screen:

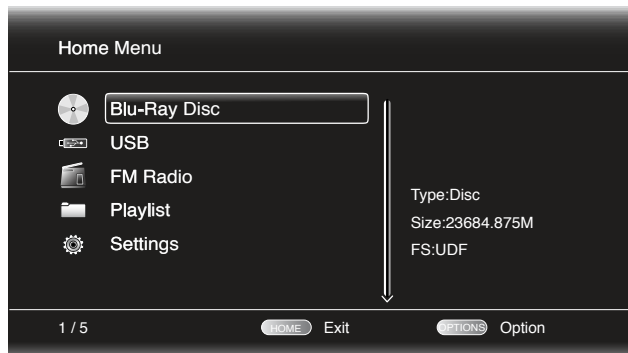

The available sources are listed on the left. If a disc has been inserted into the receiver's built-in disc slot, it will appear on the list as either "Blu-Ray Disc," "DVD Video" or "CDDA" (CD audio recording or CD data disc). If you have inserted a USB device into the receiver's USB port, it will appear on the list as "USB."

NOTE: Audio sources connected to the receiver's rear-panel digital and line inputs will not appear on the list but can be selected using the remote's "Aux" Source Selector button (see below).

To select a source from the list, use the Cursor Up/Down buttons to highlight the desired source, then press the OK button to select it.

You can also select a source directly by pressing its Source Selector button on the remote.

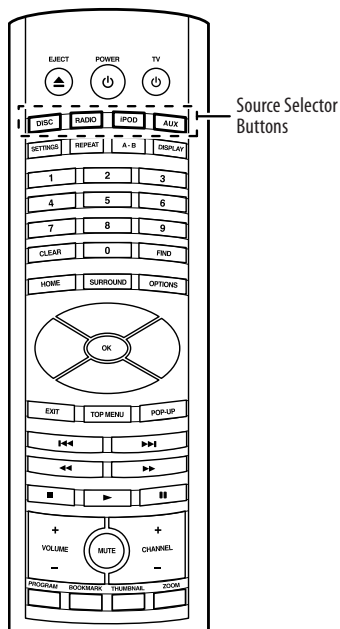

For complete information about using all of your BDS system's features, you can download the *BDS Integrated Home Theater System User Manual* from www.harmanardon.com.

BDS



HARMAN

Harman Consumer, Inc.
8500 Balboa Boulevard, Northridge, CA 91329 USA
516.255.4545 (USA only)

Made in P.R.C.

© 2010 Harman International Industries, Incorporated. All rights reserved.

Harman Kardon is a trademark of Harman International Industries, Incorporated, registered in the United States and/or other countries. Blu-ray Disc and BD-Live are trademarks of the Blu-ray Disc Association. Manufactured under license from Dolby Laboratories. Dolby, Pro Logic, and the double-D symbol are trademarks of Dolby Laboratories. Manufactured under license under U.S. Patent #'s: 5,451,942; 5,956,674; 5,974,380; 5,978,762; 6,487,535 & other U.S. and worldwide patents issued & pending. DTS and the Symbol are registered trademarks & DTS Digital Surround and the DTS logos are trademarks of DTS, Inc. Product includes software. © DTS, Inc. All Rights Reserved. HDMI, the HDMI logo, and High-Definition Multimedia Interface are trademarks or registered trademarks of HDMI Licensing LLC in the United States and other countries. Java and Java-based trademarks and logos are trademarks or registered trademarks of Sun Microsystems, Inc., in the U.S. and other countries. This item incorporates copy-protection technology that is protected by U.S. patents and other intellectual-property rights of Rovi Corporation. Reverse engineering and disassembly are prohibited.

Features, specifications and appearance are subject to change without notice.

harman/kardon
by HARMAN

www.harmankardon.com